

Introduction

The ISL6228HIEVAL3Z evaluation board demonstrates the performance of the ISL6228 dual-channel PWM controller. The ISL6228 features Intersil's Robust Ripple Regulator (R³) technology. Channel-1 output voltage is 1.05V or 1.2V, pending the state of switch S5. Channel-2 output voltage is 1.2V. Each channel has an on-board dynamic-load generator included for evaluating the transient-load response. It applies a 300µs pulse of 20A load across V_{O1} and GND, and it also applies a 300µs pulse of 20A load across V_{O2} and GND.

The contents of this document include:

- Recommended Test Equipment
- Interface Connections
- Switch Descriptions
- Test Point Descriptions
- Design Criteria
- Typical Performance
 - Efficiency
 - Start-up
 - Shut-down
 - Steady State, CCM
 - Steady State, DCM
 - Load-transient response
- Evaluation Board Documentation
 - Bill of Materials
 - Schematic
 - Silk-screen Plots
 - Board Layer Plots

TABLE 1. DC/DC DESIGN CRITERIA

PARAMETER	VALUE	UNITS
V _{IN}	3.3 to 25	VDC
V _O	0.6 to 5	VDC
Full-load	20	ADC
PWM Frequency	270, 300	kHz

Recommended Equipment

- (QTY 2) Adjustable 25V, 3A Power Supply
- (QTY 1) Fixed 5V, 100mA Power Supply
- (QTY 1) Fixed 12V, 100mA Power Supply
- (QTY 1) Adjustable 20A Constant Current Electronic Load
- (QTY 1) Digital Voltmeter
- (QTY 1) Four-Channel Oscilloscope

Interface Connections

- V_{IN1}: Input voltage to the power stage of Channel-1
 - J14: V_{IN1} positive power input
 - TP20: V_{IN1} positive voltage sense
 - J14: V_{IN1} return power input
 - TP21: V_{IN1} return voltage sense
- V_{IN2}: Input voltage to the power stage of Channel-2
 - J1: V_{IN2} positive power input
 - TP9: V_{IN2} positive voltage sense
 - J2: V_{IN2} return power input
 - TP10: V_{IN2} return voltage sense
- V_{O1}: Regulated output voltage from Channel-1
 - J9: V_{O1} positive power output
 - TP13: V_{O1} positive voltage sense
 - J10: V_{O1} return power output
 - TP14: V_{O1} return voltage sense
- V_{O2}: Regulated output voltage from Channel-2
 - J7: V_{O2} positive power output
 - TP11: V_{O2} positive voltage sense
 - J8: V_{O2} return power output
 - TP12: V_{O2} return voltage sense
- VCC: +5V input voltage
 - TP1: 5V positive input
 - TP2: 5V return input
- +12V: Input voltage for the dynamic-load generator
 - TP15: 12V positive input
 - TP16: 12V return input

Test Set-up

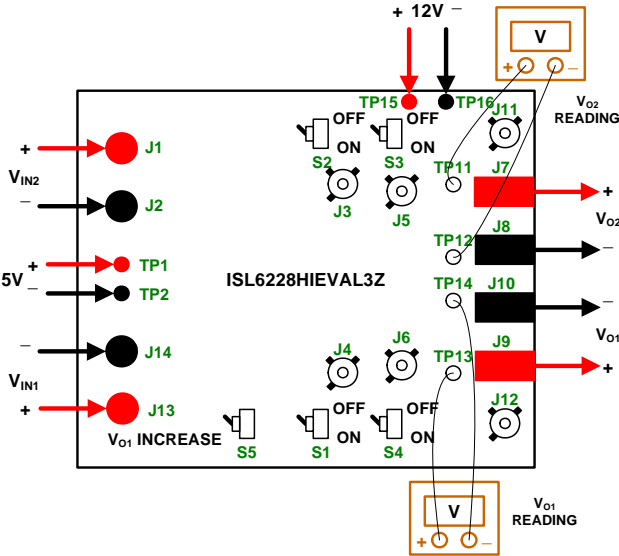

FIGURE 1. TEST SET-UP

Switch Descriptions

- S1: Channel-1 Enable
 - OFF: Short the Channel-1 EN pin to GND (disable PWM)
 - ON: Allow the Channel-1 EN pin to pull-up to +5V (enable PWM)
- S4: Channel-1 Dynamic Load
 - OFF: On-board Channel-1 dynamic load disabled
 - ON: On-board Channel-1 dynamic load enabled
- S5: Channel-1 V_O Increase
 - OFF: V_{O1} is 1.05V, determined by R_{15} and R_{23} .
 - ON: Parallel R_{49} with R_{15} . V_{O1} is 1.2V.
- S2: Channel-2 Enable
 - OFF: Short the Channel-2 EN pin to GND (disable PWM)
 - ON: Allow the Channel-2 EN pin to pull-up to +5V (enable PWM)
- S3: Channel-2 Dynamic Load
 - OFF: On-board Channel-2 dynamic load disabled
 - ON: On-board Channel-2 dynamic load enabled

Test Point Descriptions

- J4: Scope-probe socket for measuring PHASE1
- J6: Scope-probe socket for measuring V_{O1}
- J12: Scope-probe socket for measuring the current of the Channel-1 on-board transient-load emulator
- J3: Scope-probe socket for measuring the PHASE2 node
- J5: Scope-probe socket for measuring V_{O2}
- J11: Scope-probe socket for measuring the current of the Channel-2 on-board transient-load emulator
- TP1: Monitor the 5V positive input
- TP2: Monitor the 5V return input
- TP3: Monitor the PGOOD2 pin
- TP4: Monitor the PGOOD1 pin
- TP5: The common node of R_{24} and R_{20} ; Useful for Channel-1 loop gain measurement.
- TP6: The common node of R_{25} and R_{23} ; Useful for Channel-2 loop gain measurement
- TP7: The V_{O1} side of R_{24} ; Useful for Channel-1 loop gain measurement.
- TP8: The V_{O2} side of R_{25} ; Useful for Channel-1 loop gain measurement.
- TP9: Monitor the V_{IN1} positive input
- TP10: Monitor the V_{IN1} return input
- TP11: Monitor the positive V_{O1} output
- TP12: Monitor the V_{O1} return output
- TP13: Monitor the positive V_{O2} output
- TP14: Monitor the V_{O2} return output
- TP15: Monitor the 12V positive input
- TP16: Monitor the 12V return input
- TP17: Monitor the EN1 pin
- TP18: Monitor the gate of transistor Q_{18}
- TP19: Monitor the EN2 pin
- TP20: Monitor the V_{IN2} positive input
- TP21: Monitor the V_{IN2} return input

Typical Performance

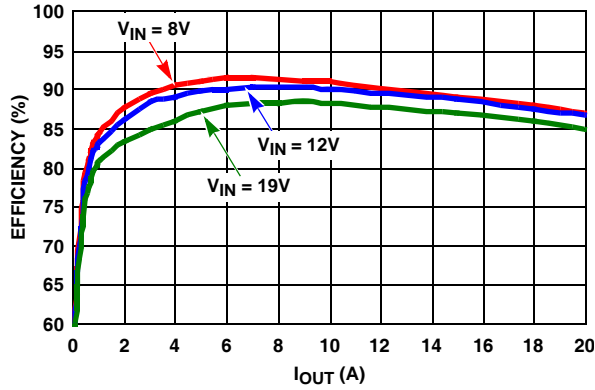

FIGURE 2. CHANNEL-1 EFFICIENCY AT $V_O = 1.05V$

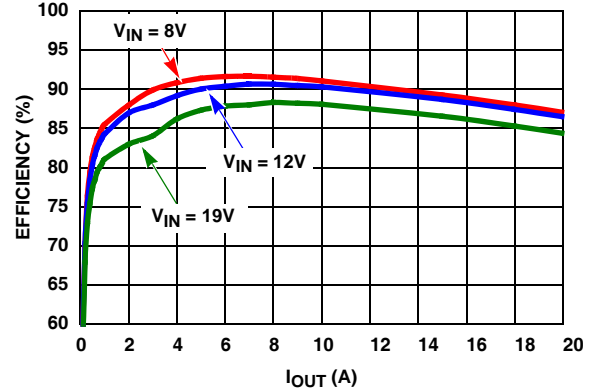

FIGURE 3. CHANNEL-2 EFFICIENCY AT $V_O = 1.2V$

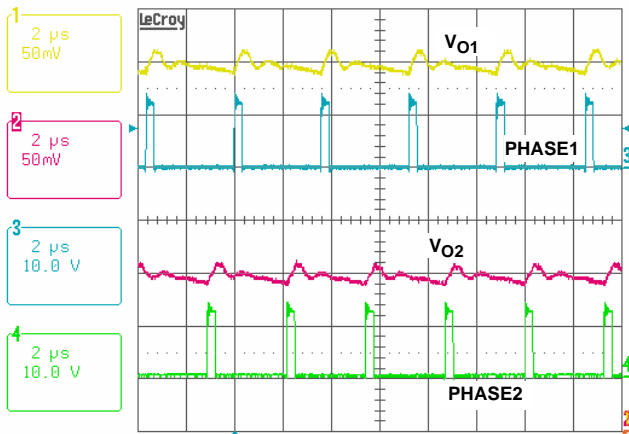

FIGURE 4. CCM STEADY-STATE OPERATION, $V_{IN} = 12V$, $V_{O1} = 1.05V$, $I_{O1} = 5A$, $V_{O2} = 1.8A$, $I_{O2} = 6A$

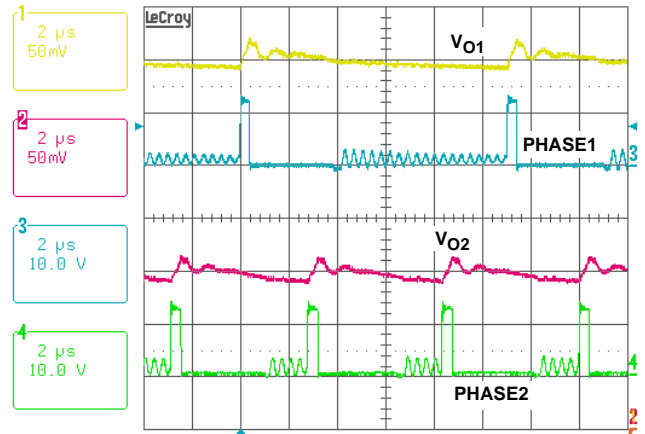

FIGURE 5. DCM STEADY-STATE OPERATION, $V_{IN} = 12V$, $V_{O1} = 1.5V$, $I_{O1} = 2A$, $V_{O2} = 1.8V$, $I_{O2} = 2A$

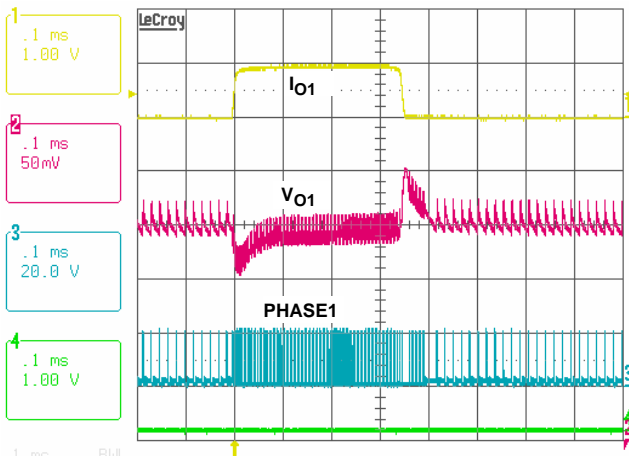

FIGURE 6. TRANSIENT RESPONSE, $V_{IN} = 19V$, $V_O = 1.05V$, $I_O = 1A/21A @ 2.55A/\mu s$

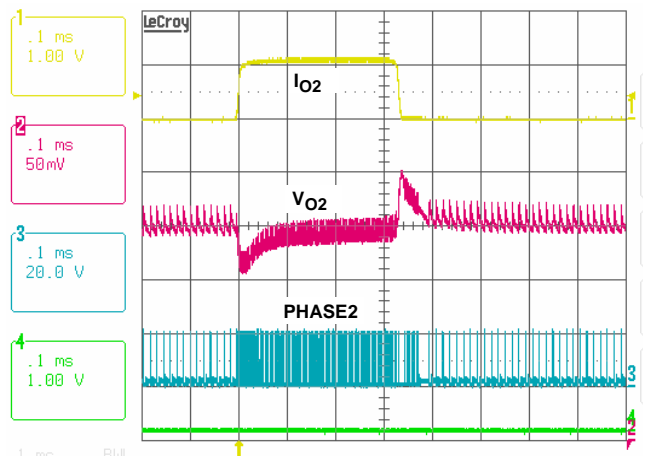

FIGURE 7. TRANSIENT RESPONSE, $V_{IN} = 19V$, $V_O = 1.2V$, $I_O = 1A/21A @ 2.55A/\mu s$

Typical Performance (Continued)

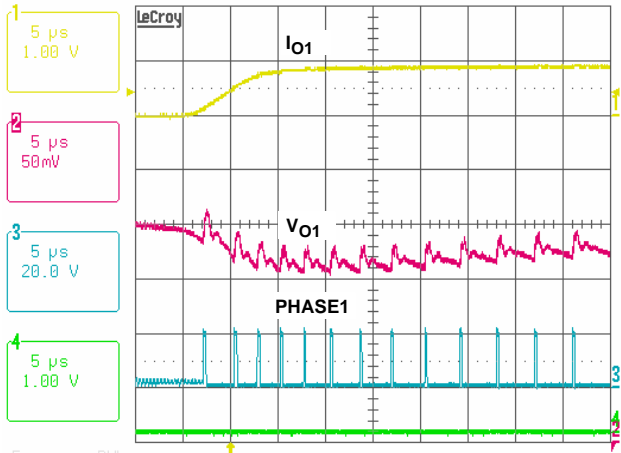

FIGURE 8. LOAD INSERTION RESPONSE, $V_{IN} = 19V$, $V_O = 1.05V$, $I_O = 1A/21A @ 2.55A/\mu s$

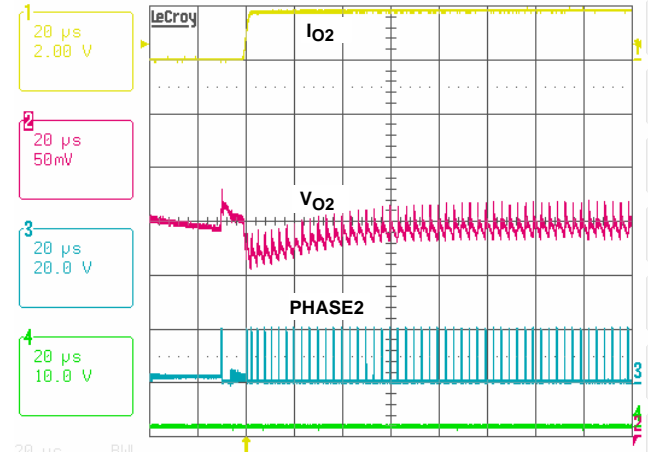

FIGURE 9. LOAD INSERTION RESPONSE, $V_{IN} = 19V$, $V_O = 1.8V$, $I_O = 0.1A/5.1A @ 2.55A/\mu s$

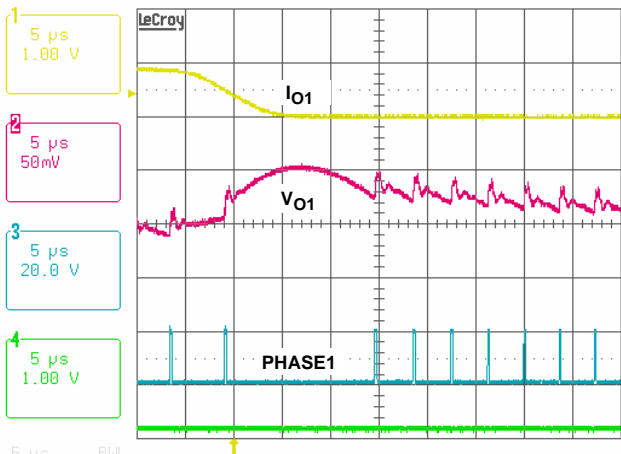

FIGURE 10. LOAD RELEASE RESPONSE, $V_{IN} = 19V$, $V_O = 1.05V$, $I_O = 1A/21A @ 2.55A/\mu s$

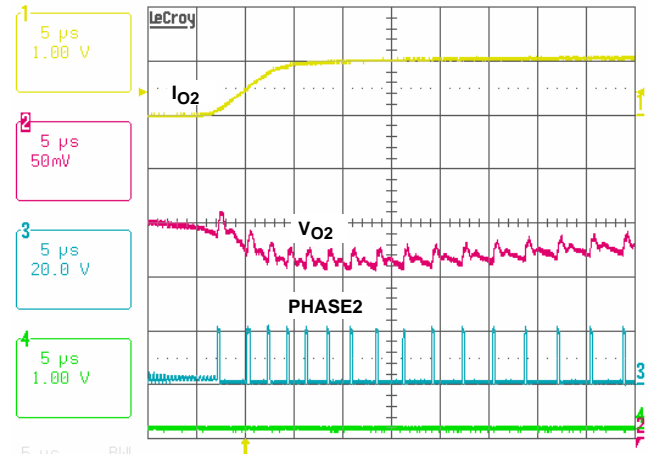

FIGURE 11. LOAD RELEASE RESPONSE, $V_{IN} = 19V$, $V_O = 1.2V$, $I_O = 1A/21A @ 2.55A/\mu s$

Application Note 1322

Bill of Materials

QTY	REFERENCE	DESCRIPTION	MANUFACTURER	PART NUMBER
0	DNP (C8, C9)	CAP, RADIAL, 56µF, 25V, ROHS	SANYO	25SP56M
2	C1, C3	CAP, SMD, 0603, 1000pF, 16V, 10%, X7R, ROHS	VENKEL	H1045-00102-16V10-T
5	C20, C21, C37, C40, C41	CAP, SMD, 0603, 0.1µF, 16V, 10%, X7R, ROHS	MURATA	H1045-00104-16V10-T
6	C2, C7, C30, C31, C36, C39	CAP, SMD, 0603, 1µF, 16V, 20%, Y5V, ROHS	MURATA	H1045-00105-16V20-T
2	C18, C19	CAP, SMD, 0603, 10µF, 6.3V, 20%, X5R, ROHS	TDK	H1045-00106-6R3V20-T
2	C5, C6	CAP, SMD, 0603, 1500pF, 50V, 10%, X7R, ROHS	MURATA	H1045-00152-50V10-T
2	C14, C15	CAP, SMD, 0603, 0.22µF, 16V, 10%, X7R, ROHS	TDK	H1045-00224-16V10-T
2	C4, C38	CAP, SMD, 0603, 0.22µF, 25V, 20%, X7R, ROHS	VENKEL	H1045-00224-25V20-T
4	C32 to C35	CAP, SMD, 0805, 10µF, 16V, 10%, X5R, ROHS	PANASONIC	H1046-00106-16V10-T
2	C16, C17	CAP, SMD, 1206, 1µF, 25V, 20%, X5R, ROHS	PANASONIC	H1065-00105-25V20-T
4	C10 to C13	CAP, SMD, 1206, 10µF, 25V, 20%, X5R, ROHS	PANASONIC	H1065-00106-25V20-T
8	C22 to C29	CAP-LOW ESR, SMD, D3L, 330µF, 6.3V, 20%, POSCAP, ROHS	SANYO	6TPF330M9L
2	J1, J13	CONN-GEN, BIND.POST, INSUL-RED, THMBNUT-GND	JOHNSON COMPONENTS	111-0702-001
2	J2, J14	CONN-GEN, BIND.POST, INSUL-BLK, THMBNUT-GND	JOHNSON COMPONENTS	111-0703-001
0	J3 to J6, J11, J12	CONN-SCOPE PROBE TEST POINT, PCB MNT	TEKTRONIX	131-4353-00
4	TP1, TP2, TP15, TP16	CONN-TURRET, TERMINAL POST, TH, ROHS	KEYSTONE	1514-2
15	TP3 to TP14, TP17 to TP19	CONN-MINI TEST POINT, VERTICAL, WHITE, ROHS	KEYSTONE	5002
0	DNP (D3, D4)	DIODE-SCHOTTKY, SMD, SMB, 2P, 40V, 3A LOW VF, Pb-FREE	DIODES INC.	B340LB-13-F-T
2	D5, D6	DIODE-SCHOTTKY, SMD, SOT23, 3P, 30V, 200mA, DUAL DIODE	FAIRCHILD	BAT54S-T
2	D1, D2	LED, SMD, 4P, OTHER, POLARIZED RED/GRN	LUMEX	SSL-LXA3025IGC
2	L1, L2	PWR CHOKE COIL, SMD, 13x12.9, 0.82µH, 20%, 33A, ROHS	Vishay	IHLP5050FDERR82M01
2	U2, U3	IC-HI FREQ BRIDGE DRIVER, 8P, SOIC, 100V, ROHS	INTERSIL	HIP2100IBZ
1	U1	IC-DUAL CHANNEL CONTROLLER, 28P, QFN, ROHS	INTERSIL	ISL6228HRZ
5	Q11 to Q14, Q18	TRANSISTOR, N-CHANNEL, 3LD, SOT-23, 60V, 115mA, ROHS	DIODES INC.	2N7002-7-F-T
0	DNP (Q5, Q10)	TRANSISTOR-DUAL N-CHANNEL, 8P, SOIC, 30V, 7.5A, ROHS	FAIRCHILD	FDS6990AS
4	Q1, Q2, Q6, Q7	TRANSIST-MOS, N-CHANNEL, 8P, SOIC, 30V, 9.1mΩ RDS, ROHS	INTERNATIONAL RECTIFIER	IRF7821PBF
4	Q3, Q4, Q8, Q9	TRANSIST-MOS, N-CHANNEL, 8P, SOIC, 30V, 4.0mΩ RDS, ROHS	INTERNATIONAL RECTIFIER	IRF7832PBF
2	Q15, Q16	TRANSIST-MOS, N-CHANNEL, SMD, TO-252, 30V, 20A, ROHS	VISHAY	SUD50N03-07-E3
4	R9, R52, R53, R54	RES, SMD, 0603, 2Ω, 1/10W, 1%, TF, ROHS	YAGEO	H2511-00020-1/10W1-T
0	DNP (R12, R13, R57, R58)	RESISTOR, SMD, 0603, 0Ω, 1/10W, TF, ROHS	KOA	H2511-00R00-1/10W-T
10	R10, R11, R24, R25, R48, R50, R55, R56, R59, R60	RESISTOR, SMD, 0603, 0Ω, 1/10W, TF, ROHS	KOA	H2511-00R00-1/10W-T
5	R7, R8, R21, R22, R51	RES, SMD, 0603, 10k, 1/10W, 1%, TF, ROHS	KOA	H2511-01002-1/10W1-T
2	R35, R37	RES, SMD, 0603, 4.12k, 1/10W, 1%, TF, ROHS	PANASONIC	H2511-04121-1/10W1-T

Application Note 1322

Bill of Materials (Continued)

QTY	REFERENCE	DESCRIPTION	MANUFACTURER	PART NUMBER
1	R49	RES, SMD, 0603, 422k, 1/10W, 1%, TF, ROHS	YAGEO	H2511-04223-1/10W1-T
2	R26, R27	RES, SMD, 0603, 2k, 1/10W, 1%, TF, ROHS	KOA	H2511-02001-1/10W1-T
1	R3	RES, SMD, 0603, 18.2k, 1/10W, 1%, TF, ROHS	KOA	H2511-01822-1/10W1-T
1	R4	RES, SMD, 0603, 22.1k, 1/10W, 1%, TF, ROHS	PANASONIC	H2511-02212-1/10W1-T
2	R34, R36	RES, SMD, 0603, 8.45k, 1/10W, 1%, TF, ROHS	KOA	H2511-08451-1/10W1-T
4	R1, R2, R5, R6	RES, SMD, 0603, 499 Ω , 1/10W, 1%, TF, ROHS	KOA	H2511-04990-1/10W1-T
2	R30, R31	RES, SMD, 0603, 49.9k, 1/10W, 1%, TF, ROHS	VENKEL	H2511-04992-1/10W1-T
1	R15	RES, SMD, 0603, 140k, 1/10W, 1%, TF, ROHS	YAGEO	H2511-01403-1/10W1-T
4	R16, R17, R28, R29	RES, SMD, 0603, 4.53k, 1/10W, 1%, TF, ROHS	ROHM	H2511-04531-1/10W1-T
2	R18, R19	RES, SMD, 0603, 845 Ω , 1/10W, 1%, TF, ROHS	VENKEL	H2511-08450-1/10W1-T
3	R14, R20, R23	RES, SMD, 0603, 105k, 1/10W, 1%, TF, ROHS	VENKEL	H2511-01053-1/10W1-T
0	DNP (R32)	RES, SMD, 1206, 1.5 Ω , 1/4W, 1%, TF, ROHS	VENKEL	H2513-001R5-1/4W1-T
2	R38, R40	RES, SMD, 1206, 1.5 Ω , 1/4W, 1%, TF, ROHS	VENKEL	H2513-001R5-1/4W1-T
3	R33, R39, R41	RES, SMD, 1206, 0.75 Ω , 1/2W, 1%, TF, ROHS	SUSUMU	RL1632R-R750-F
6	R42 to R47	RES, SMD, 1206, 0.2 Ω , 1/4W, 1%, TF, ROHS	VISHAY	WSL1206R2000FEA
5	S1 to S5	SWITCH-TOGGLE, SMD, ULTRAMINI, 1P, SPST MINI	C&K COMPONENTS	GT11MSCBE-T
4	J7 to J10	MTG HDWR, CBL.TERMINAL-LUG and SCREW, 6AWG to 14AWG	BERG/FCI	KPA8CTP

ISL6228HIEVAL3Z Evaluation Board Schematic

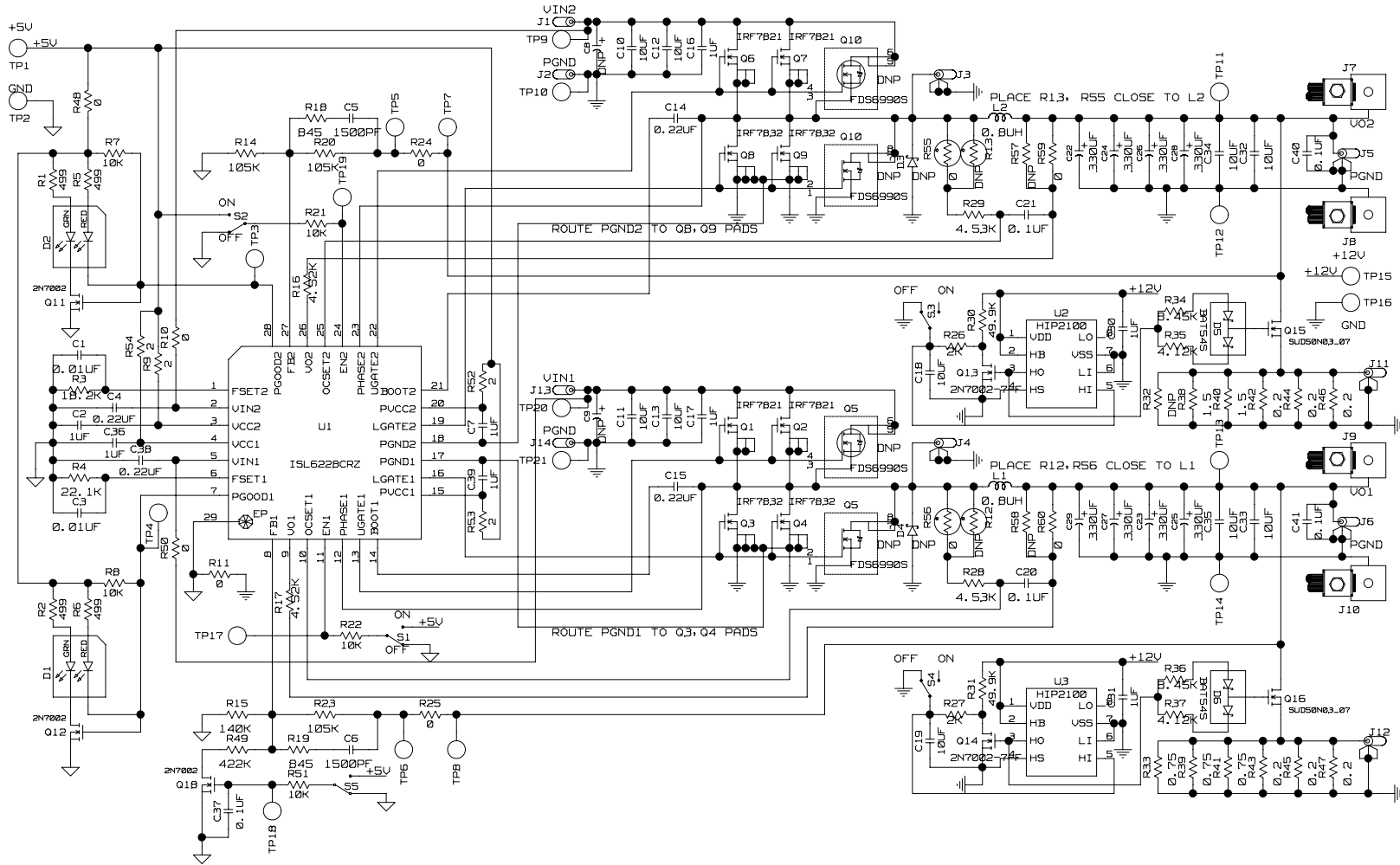

FIGURE 12. ISL6228HIEVAL3Z SCHEMATIC

ISL6228HIEVAL3Z Evaluation Board Layout

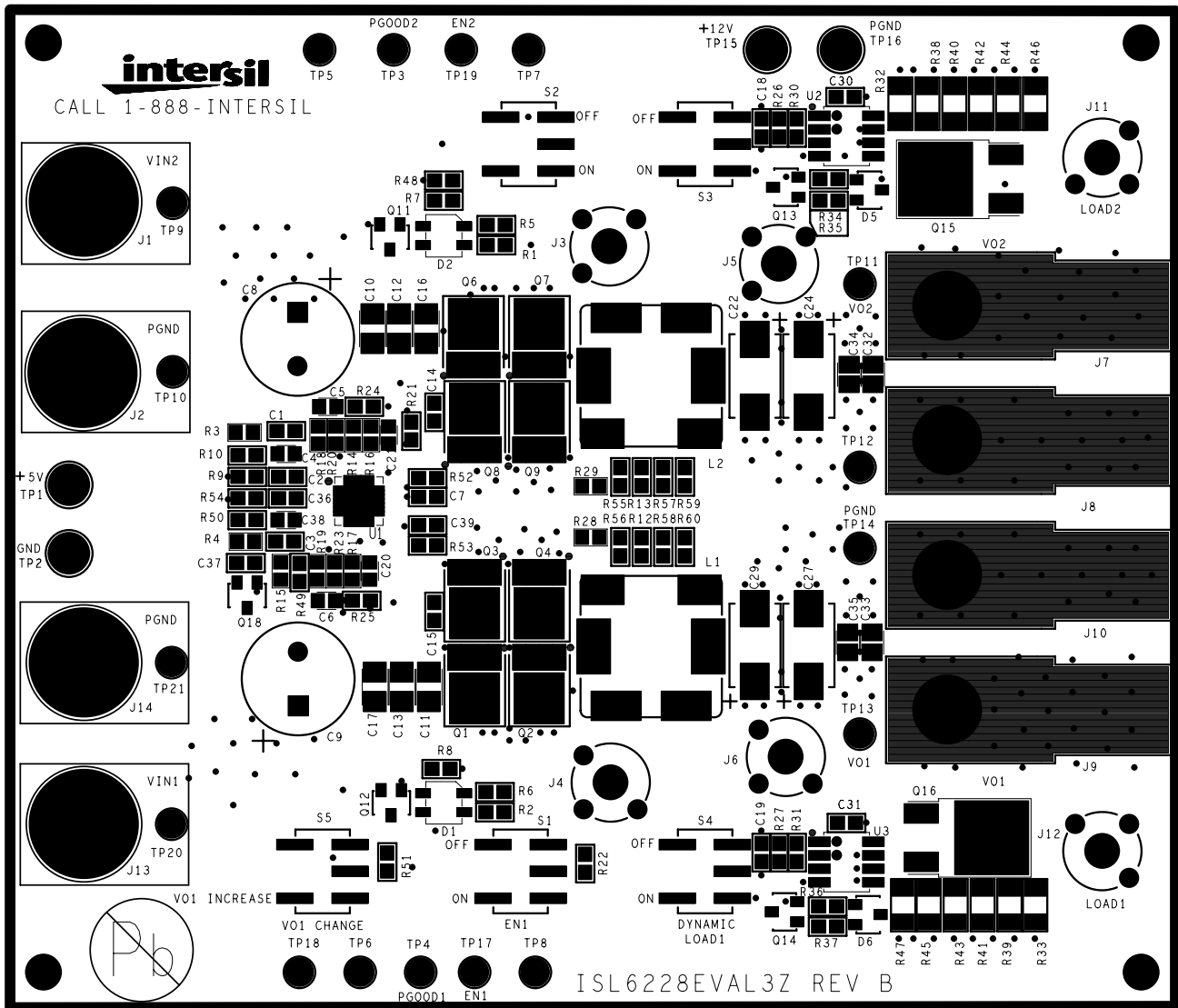

FIGURE 13. TOP SILKSCREEN

ISL6228HIEVAL3Z Evaluation Board Layout (Continued)

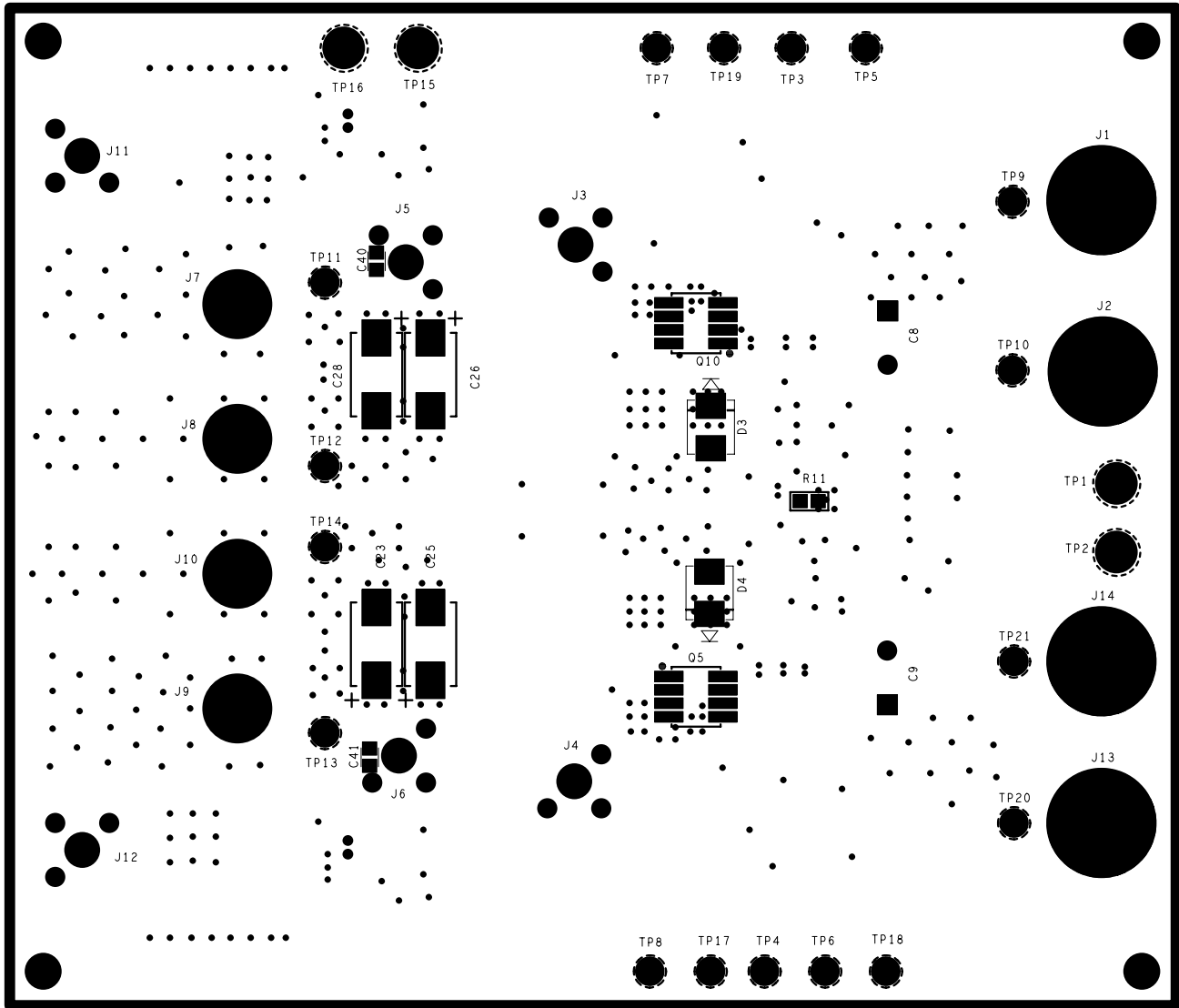

FIGURE 14. BOTTOM SILKSCREEN

ISL6228HIEVAL3Z Evaluation Board Layout (Continued)

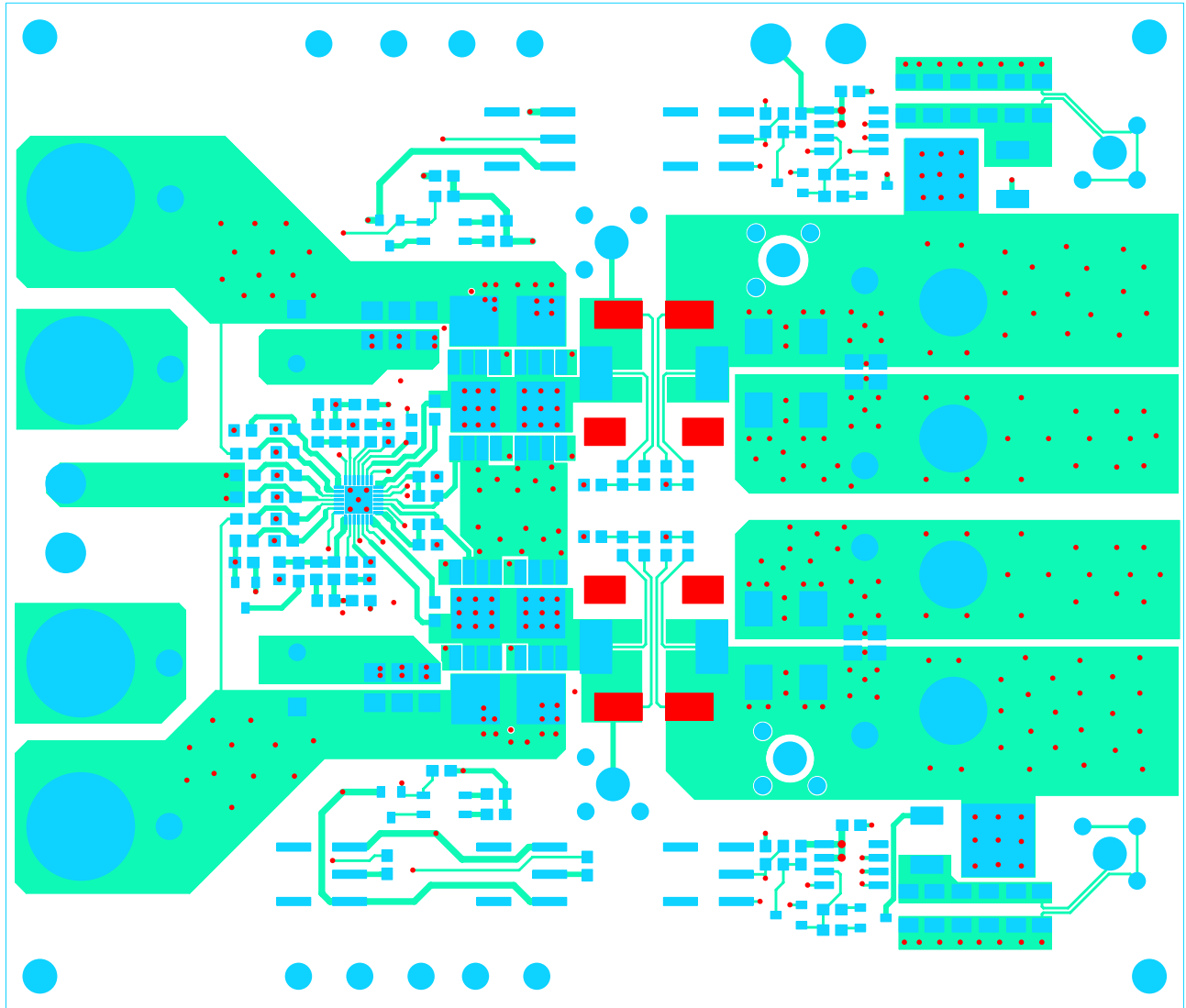

FIGURE 15. LAYER 1

ISL6228HIEVAL3Z Evaluation Board Layout (Continued)

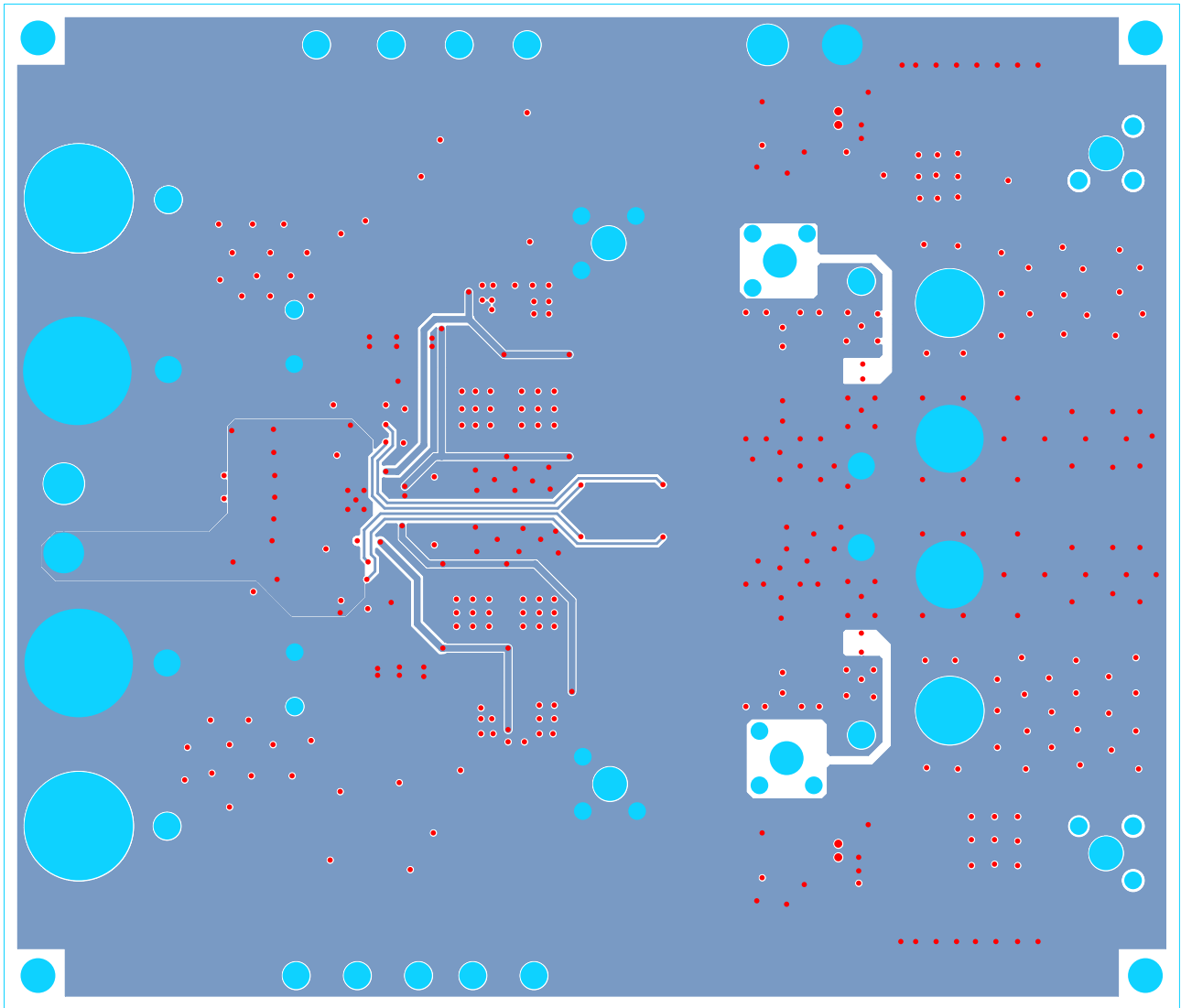

FIGURE 16. LAYER 2

ISL6228HIEVAL3Z Evaluation Board Layout (Continued)

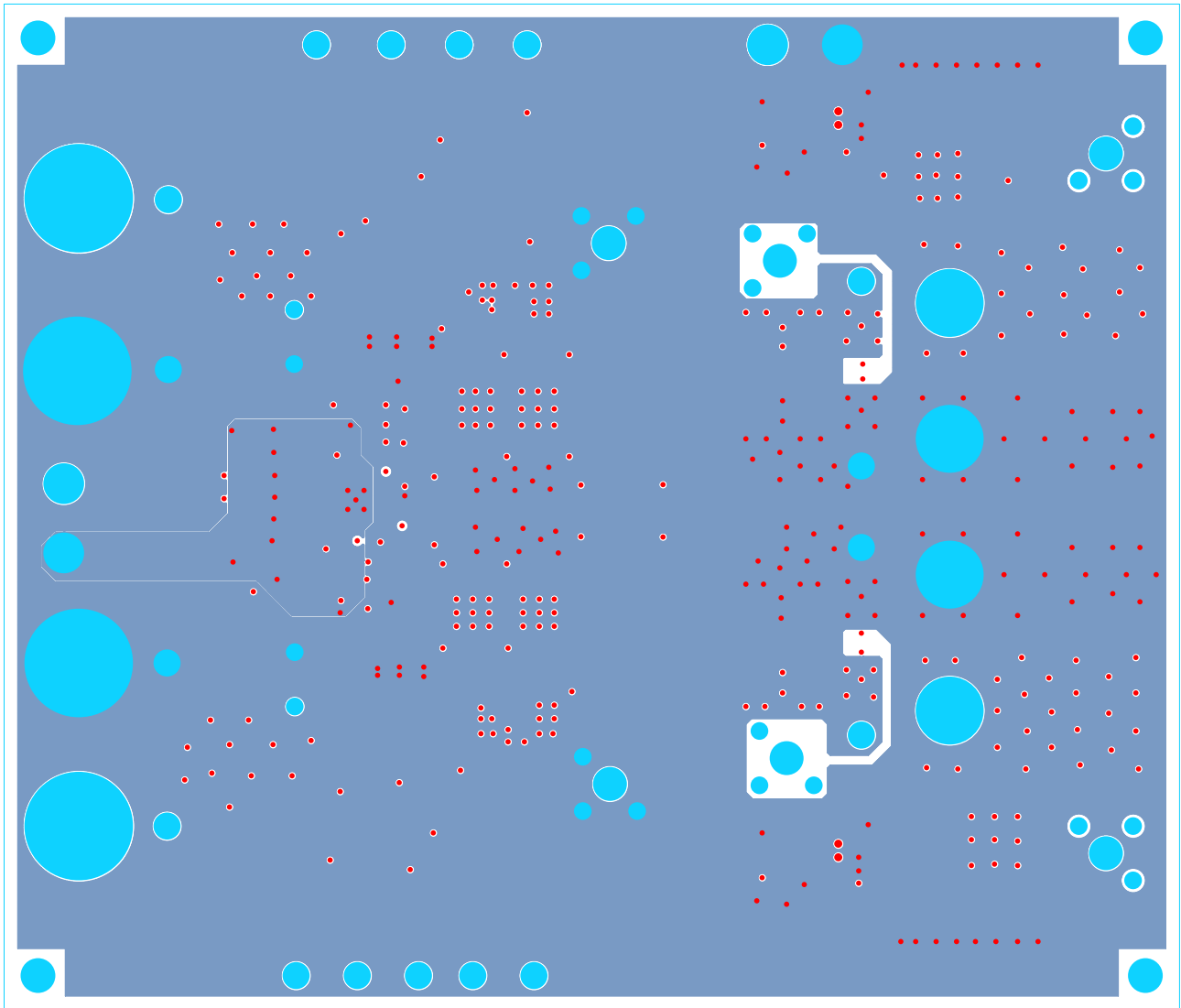

FIGURE 17. LAYER 3

ISL6228HIEVAL3Z Evaluation Board Layout (Continued)

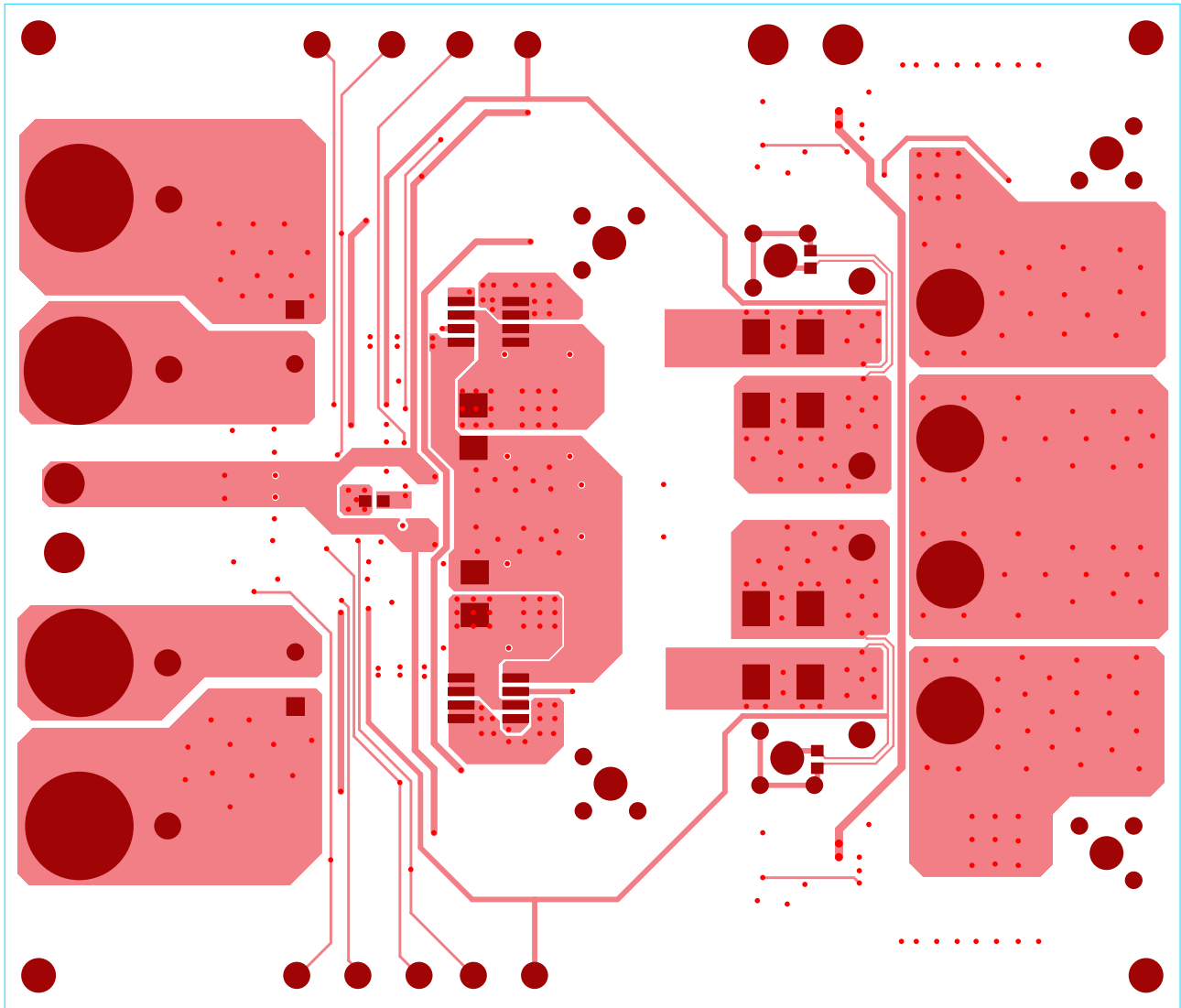

FIGURE 18. LAYER 4

Intersil Corporation reserves the right to make changes in circuit design, software and/or specifications at any time without notice. Accordingly, the reader is cautioned to verify that the Application Note or Technical Brief is current before proceeding.

For information regarding Intersil Corporation and its products, see www.intersil.com